



MS-MSD-300-3500-2011-11-15

POWER INVERTER

USER MANUAL

- MS Series Inverter
- MSD Series Digital Inverter

CONTENTS

1-2	1. Important Safety Instructions
2-3	2. Introduction
3	3. Inverter Materials List
4-5	4. Inverter Features
6-8	5. Inverter Installation
8	6. Inverter Location
8-9	7. Cables for DC Input and Ground
9	8. Fuses (or circuit breakers)
9-11	9. Install the Inverter
12-13	10. Inverter Operation
13	11. Digital LED Indication Function (for MSD series digital inverter Only)
13-14	12. Operating Several Loads at once.
14-15	13. Inverter Loads
15	14. Routine Maintenance
15	15. Recharging Batteries
16	16. Battery's Capacity Calculation
16-17	17. Troubleshooting
18-19	18. Specifications
20	19. Disposal Instructions
20	20. Warranty and Service Agreements

1. Important Safety Instructions

IMPORTANT: Read and save this owner's guide for future reference.

This chapter contains important safety and installation instructions for our MS series inverter and MSD series digital inverter. Each time, before using the power inverter, read all instructions and cautionary marking on or provided with inverter and all appropriate sections of this guide.

! DANGER

ELECTRICAL SHOCK HAZARD

- Do not expose the inverter to rain, snow, spray, or bilge water. This inverter is designed for indoor use only.
- Do not operate the inverter if it has received a sharp blow, been dropped, has cracks.
- Do not disassemble the inverter. Internal capacitors remain charged after all power is disconnected.
- Disconnect both AC and DC power from the inverter before attempting any maintenance or cleaning or working on any circuits connected to the inverter. See note below.
- Do not operate the inverter with damaged or substandard wiring.
- Make sure that all wiring is in good condition and is not undersized.

Failure to follow these instructions will result in death or serious injury.

! DANGER

FIRE AND BURN HAZARD

- Do not cover or obstruct the air intake vent openings and /or install in a zero-clearance compartment.
- Do not use transformer less battery chargers in conjunction with the inverter due to overheating.

Failure to follow these instructions will result in death or serious injury.

! DANGER

EXPLOSION HAZARD

- Charge only properly rated (such as 12V) lead-acid (GEL, AGM, Flooded, or lead-calcium) rechargeable batteries because other battery types may explode and burst.
- Do not work in the vicinity of lead-acid batteries. Batteries generate explosive gases during normal operation.
- Do not install and /or operate in compartments containing flammable materials or in locations that require ignition-protected equipment.

Failure to follow these instructions will result in death or serious injury.

Notes:

1. Follow these instructions and those published by the battery manufacturer and the manufacturer of any equipment you intend to use in the vicinity of the battery. Review cautionary markings on these products and on the engine.
2. The inverter contains components which tend to produce arcs or sparks.
3. Locations include any space containing gasoline-powered machinery, fuel tanks, as well as joints, fittings, or other connections between components of the fuel system.

CAUTION

RISK OF DAMAGE TO THE INVERTER

- Never allow battery acid to drip on the inverter when reading gravity, or filling battery.
 - Never place the inverter unit directly above batteries, gases from a battery will corrode and damage the inverter.
 - Do not place a battery on top of the inverter.
- Failure to follow these instructions can damage the unit and/or damage other equipment.

2. Introduction

The MS series inverter and MSD series digital inverter designed to give you quality power, ease of use, and reliability. The MS series inverter improved base on our CAR series inverter, it is with new design case, improved technology and better workmanship. The MSD series digital inverter with digital LED, it indicates the voltage and power (V, P) constantly.

Please take a few moments to read this chapter to familiarize you with the main performance features and protection features.

2.1 QUALITY POWER & EASE OF USE

The MS series inverter and MSD series digital inverter superior features and rugged durability have been combined with ease of use: The unit is compact, light weight, and easy to install. Loads can be powered directly from inverter's outlets.

2.2 COMPREHENSIVE PROTECTION

Our MS series inverter and MSD series digital inverters are equipped with numerous protection features to guarantee safe and trouble-free operation:

- **LOW BATTERY ALARM:** Alerts you if the battery has become discharged to 10.5V or lower.
- **LOW BATTERY VOLTAGE SHUTDOWN:** Shuts the inverter down automatically if the battery voltage drops below 9.5 volts. This feature protects the battery from being completely discharged.
- **HIGH BATTERY VOLTAGE SHUTDOWN:** Shuts the inverter down automatically if the input voltage rises to 15.5 volts or more.
- **OVER LOAD SHUTDOWN:** Shuts the inverter down automatically if the loads connected to the inverter exceed the inverter's operating limits.

• **OVER TEMPERATURE SHUTDOWN:** Shuts the inverter down automatically if its internal Temperature rises above an unacceptable level.

• **OUTPUT SHORT CIRCUIT SHUTDOWN:** Shuts the inverter down automatically if a short circuit is detected in the circuitry connected to the inverter's output.

• **INPUT REVERSE POLARITY PROTECTION:** The fuse shall blow if user connect the battery in wrong polarity.

3. Inverter Materials List

The inverter ships with the following items:

- Inverter unit
- User manual
- Spare fuse
- DC cable with cigarette lighter plug / DC cable with clips
- One ON/OFF remote switch with communications cable (optional)

IMPORTANT: keep the carton and packing material in case you need to return the inverter for servicing.

Figure 1 Material List

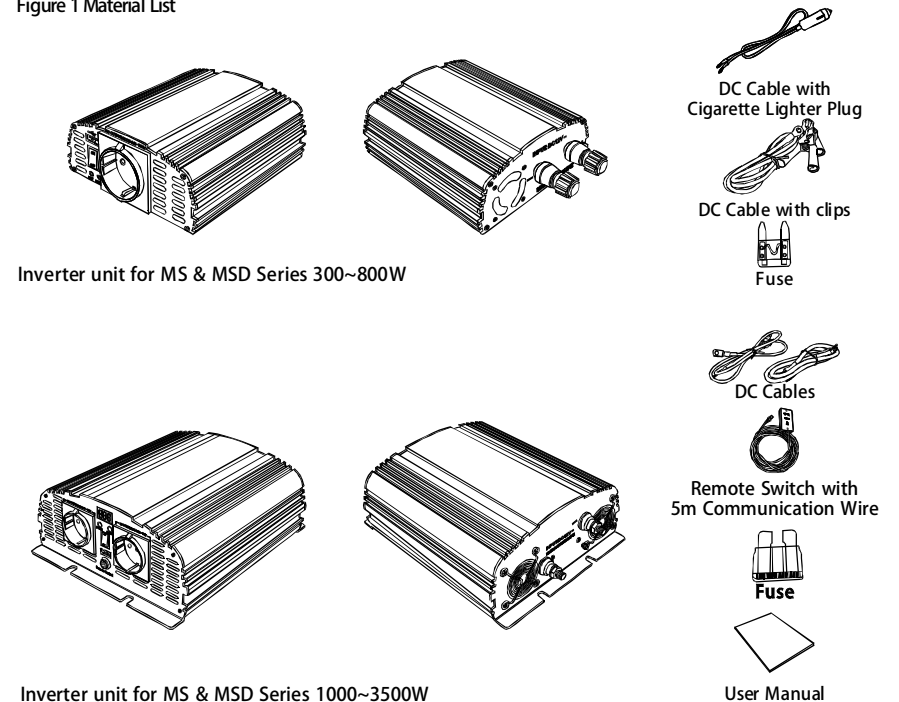

4. Inverter Features

This section describes the different parts of the inverter.

Figure 2: Output AC panel.

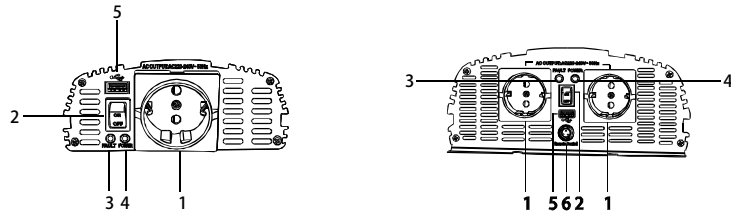

Picture NO.1: for MS Series 300~800W

Picture NO.2: for MS Series 1000~3500W

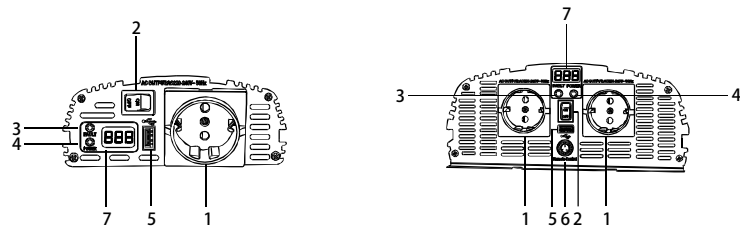

Picture NO.3: for MSD Series 300~800W

Picture NO.4: for MSD Series 1000~3500W

4.1 AC PANEL

Item	Description
1	AC outlets are used to power loads
2	ON/OFF Switch turns the Inverter on and off.
3	Fault light (red) indicates that the inverter has shutdown due to inverter overload, over temperature, short circuit, and leakage. Etc. or failure status.
4	Power light (green) indicates the inverter is operating.
5	USB port it output DC5V 500mA or 800mA for charge for your appliance.
6	Remote ON/OFF connector port is used for connecting the ON/OFF remote switch.
7	Digital display panel indicates the input voltage from battery and the rate of loaded power (for MSD series digital inverter only)

Figure 3: Input DC panel.

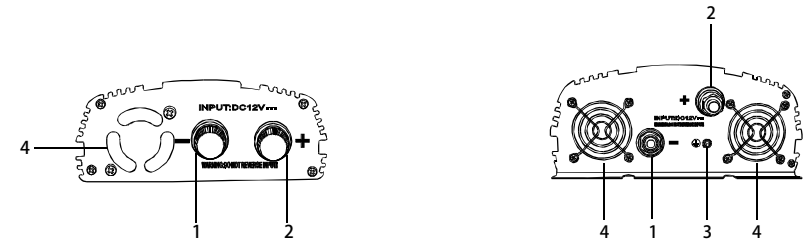

Picture NO.1: for MS Series 300~800W

Picture NO.2: for MS Series 1000~3500W

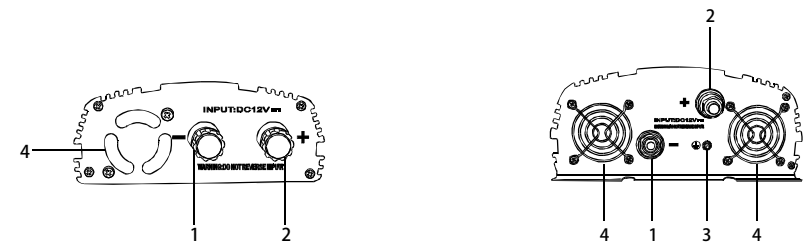

Picture NO.3: for MSD Series 300~800W

Picture NO.4: for MSD Series 1000~3500W

4.2 DC PANEL

Item	Description
1	Negative DC input terminal always connects to the negative terminal of the battery via a negative DC input cable (black battery cable).the negative DC input terminal is colored black.
2	Positive DC input terminal always connects to the positive terminal of the battery via a positive DC input cable (red battery cable).the positive DC input terminal is colored red.
3	Chassis ground screw connects to vehicle chassis, DC grounding bus or to engine's negative bus or grounding the earth.
4	Ventilation openings must not be obstructed for the proper operation of the inverter. When the inverter is mounted, then ventilation opening on the DC panel must not point up or down.

5. Inverter Installation

This section describes generation installation instructions for the power inverter.

IMPORTANT: Use a qualified installer if you do not possess the knowledge and skill necessary to follow these general instructions.

5.1 PREPARE FOR INSTALLATION

- Design your power system
- Calculate your battery requirements
- Choose an effective charging system
- Choose an appropriate location
- Prepare cables for DC input and ground

5.2 POWER SYSTEM CONNECTION EXAMPLE

Determine how you are going to use your inverter then design a power system that will give you maximum performance. The configuration shown below is some typical power system design, only for reference.

Figure 4 Typical power system designs

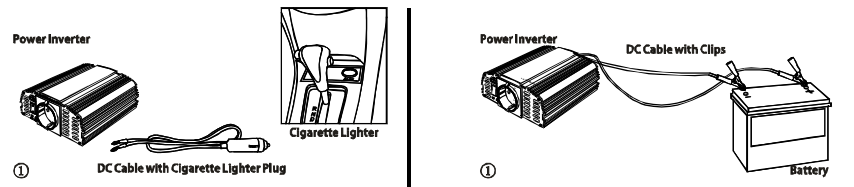

Picture NO.1: For MS Series 300~600W & MSD Series 300~600W

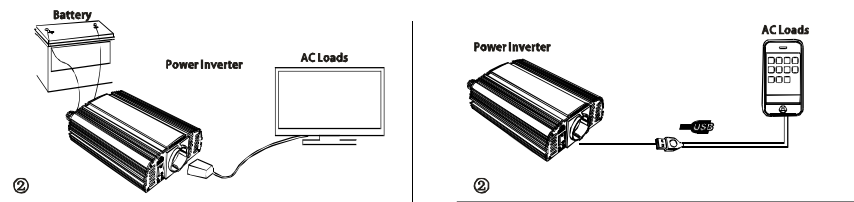

Picture NO.2: For MS Series 700~800W & MSD Series 700~800W

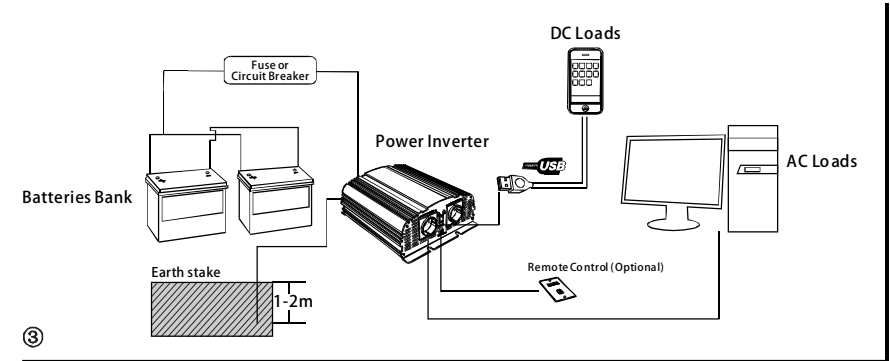

Picture NO.3: For MS Series 1000~3500W

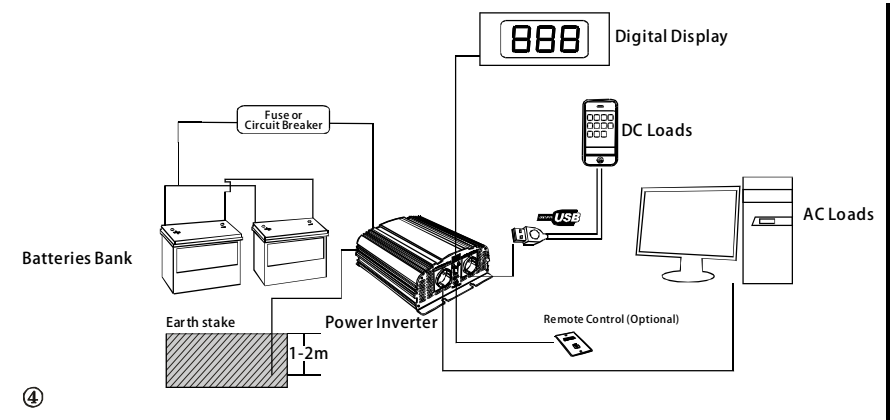

Picture NO.4: For MSD Series 1000~3500W

5.3 BATTERY REQUIREMENTS

Battery type and battery size strongly affect the performance of the power inverter. Therefore, you need to identify the type of loads your inverter will be powering and how much you will be using them between charges. Once you know how much power you need. We recommend that you purchase as much battery capacity as possible.

IMPORTANT: Connect the inverter to a 12-volt battery or 12-volt battery bank system. The inverter will not work on 6-volt battery systems and will be damaged when connected to a higher-than-12-volt battery system such as a 24-volt battery system in some trucks or recreational vehicles.

5.4 CHARGING SYSTEM:

The charging system must be appropriate for your particular installation. A well-designed charging system will ensure that power is available when you need it and that your batteries remain in top condition. Inadequate charging degraded system performance and the wrong type of charger will reduce battery life.

Contact us or visit our website to find more information about our different battery chargers.

6. Inverter Location

The Inverter power inverter must only be installed in a location that is:

DRY The inverter must be installed in a dry location not subject to moisture especially rain, spray, or splashing bilge water.

COOL The inverter should not be exposed to metal fillings or any other form of contamination.

VENTILATED The ambient air temperature should be between 0-40°C (32-104 F) for best performance.

SAFE Ventilation openings on the inverter must not be obstructed. If the inverter is mounted in a tight fitting compartment, the compartment must be ventilated with cut-outs to prevent the inverter from overheating.

CLOSE TO BATTERY The inverter is not ignition-protected equipment, so it cannot be installed in areas containing gasoline tanks or fittings which require ignition - protected equipment. We recommend that it is safest not to install any kind of electrical equipment including the inverter in these areas.

PROTECTED FROM BATTERY GASES The inverter should be installed as close as possible to the batteries, but not in the same compartment to prevent corrosion. Avoid excessive cable lengths and use the recommended wire sizes. We recommend that installing with battery cables sized to achieve less than 3% voltage drop on battery cables under full load. This will maximize the performance of the inverter.

7. Cables for DC Input and Ground

To operate safely and effectively, use low - resistance wiring between the battery and the inverter because the inverter receives high-current input from a low-voltage battery.

Run a chassis ground cable from the grounding point to chassis ground screw on the inverter' s DC panel.

There is spare DC cable inside of packing, you can use it for normal connection, if you need longer or special system installation, when purchasing cables for DC input and ground:

- Use the enough size DC input cable if you use longer cable.

- Use a matching cable size for ground cable. Terminate one end with an appropriately-sized ring connector.

- Use standard copper wires, avoiding aluminum wires due to their higher-resistance rating. Have your DC input cables crimped and terminated with appropriately sized ring connectors at the store of purchase.

8. Fuses (or circuit breakers)

For safety concern, you can connect a DC-rated fuse or a DC-rated circuit breakers on the positive cable line in your power system, following these recommendations when you purchasing fuses or circuit breakers.

- Select a fuse or circuit breaker with a maximum rating of 150 Adc.
- Determine the short-circuit current rating of the battery and choose a battery fuses that withstand the short circuit current that may be generated by the battery.

9. Install the Inverter

Review and follow the safety guidelines in “ important safety instruction ” on page before proceeding with installation.

9.1 OVERVIEW OF INSTALLATION STEPS

- Mount the inverter
- Connect the chassis ground
- Connect the DC cables

9.2 MOUNT THE INVERTER

1. Make sure the inverter' s ON/OFF switch is in the off position.

2. Select an appropriate mounting location and orientation. The inverter must be oriented in one of the following ways:

- Horizontally on a vertical surface.(the ventilation opening on the DC end must not point up or down.)

- On or under a horizontal surface

3. Hold the inverter against the mounting surface, mark the positions of the mounting screws, and then remove the inverter.

4. Pilot drill the four mounting holes.

5. Fasten the inverter to the mounting surface using corrosion-resistant fasteners proper sized.

Important: Do not mount the inverter under the engine hood of a vehicle if you install the inverter on vehicle.

9.3 CONNECT THE CHASSIS GROUND

1. Make sure the inverter's ON/OFF switch is in the OFF position.

2. Locate the screw terminal labeled chassis ground on the DC panel and remove the chassis ground screw and star washer.

3. Attach the ground cable's ring connector to the screw terminal on the inverter and secure with the star washer and chassis ground screw.

4. Attach the other end of the ground cable to the vehicle chassis via a grounding point on the vehicle if you install the inverter in vehicle. Or attach the other end of the ground cable to the earth if you install inverter for household use.

! DANGER

ELECTICAL SHOCK HAZARD

- Never operate the inverter without properly connecting the chassis ground. Failure to follow these instructions will result in death or serious injury.

9.4 CONNECT THE DC CABLE

IMPORTANT: Before proceeding, make sure that your DC input cables are properly terminated with ring connectors appropriate for the size of the cable you are using. We advise you use the DC input cable inside of our inverters packing.

1. Make sure the inverter's ON/OFF switch is in the off position

2. Working on the inverter's positive DC input terminal first, attach one end of the positive DC input cable to the positive DC input terminal on the inverter.

IMPORTANT: Do not over tighten the nut on the inverter terminal. Damage to the inverter terminal may result. However, loose connections can cause excessive voltage drop and may cause overheated

wires and melted insulation.

3. Attach a fuse holder (with an installed fuse) to the other end of the positive battery cable. Alternatively, if you using a circuit breaker, install the circuit breaker on the positive terminal of the battery.

4. Attach the fused end on the positive DC input cable to the positive terminal of the battery. Alternatively, if you are using a circuit breaker, attach the other end of the positive DC input cable to the circuit breaker on the battery.

! DANGER

DAMAGE FROM A REVERSE POLARITY CONNECTION

- DC power connection to the inverter must be positive to positive and negative to negative.
- A reverse polarity connection (connecting positive to negative) will blow the internal fuse inside the inverter and can cause damage to the inverter.

Damage caused by a reverse polarity connection is not covered by the warranty. Failure to follow these instructions can damage the unit and or damage other equipment.

! DANGER

EXPLOSION AND/OR FIRE HAZARD

- Thoroughly ventilate the battery compartment before proceeding to connect the negative DC input cable to the battery.
- It is always possible that flammable fumes are preventing, so exercise extreme caution. Failure to follow these instructions will result in death or serious injury.

5. Working on the inverter's negative DC input terminal, attach one end of the negative DC input cable to the negative DC input terminal on the inverter.

6. Attach the other end of the negative DC input cable to the negative terminal of the battery if you have installed a battery selector switch, set it to off when making the connection to prevent sparking.

NOTE: This is last cable connection, A spark is normal when you make the connection to the battery without a battery selector switch. If you have installed a battery selector switch, use it to select one

10. Inverter Operation

This section explains how to operate the inverter efficiently and effectively:

- Gives procedures for operating the inverter from the front panel
- Discusses operating limits and inverter loads

- Discusses battery charging frequency
- Provides information about routine maintenance

Note: The inverter's output power efficient different when input voltage different

! DANGER

ELECTRICAL SHOCK HAZARD

- The inverter's ON/OFF switch does not disconnect DC battery power from the inverter. You must disconnect AC and DC power before working on any circuits connected to the inverter.
- Failure to follow these instructions can result in death or serious injury.

10.1 TURNING THE INVERTER ON AND OFF

The ON/OFF switch on the inverter's front panel is the main ON/OFF switch that turns the control circuit in the inverter on and off.

To turn the inverter on and off from its front panel:

- Move the ON/OFF switch to the ON position to turn the inverter on.
- Move the ON/OFF switch to the OFF position to turn the inverter off.

When switch is off, the inverter draws a very low current from the battery.

To turn the inverter on and off from the remote switch:

- Make sure the main ON/OFF switch on the front panel is turned ON.
- Move the remote ON/OFF switch to the ON position to turn the inverter ON.
- Move the remote ON/OFF switch to the OFF position to turn the inverter OFF.

When the remote switch is off, the inverter draws a very low current from the battery.

IMPORTANT:

The inverter draws a current from the battery with the main ON/OFF switch turned on and no load connected. If the main switch is left on, even with no loads the inverter will eventually discharge the battery. To prevent unnecessary battery discharge, turn the inverter off when you are not using it.

10.2 THE OUTLETS (THE TYPE OPTIONAL) INSTALLED ON INVERTER AS FOLLOWS:

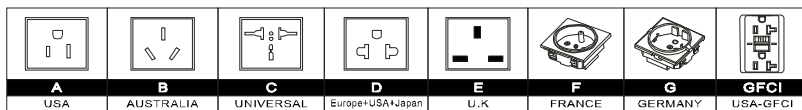

10.2.1 Testing the GFCI (if you choose the inverter with GFCI outlet) Perform the following GFCI test:

1. Turn the inverter on.
2. Plug a simple appliance, such as a lamp, in the GFCI outlet. Turn the lamp on.
3. Press the TEST button. Observe a clicking sound. The lamp turns off.
4. Press the RESET button all the way to the bottom until the button locks into position. The lamp turns back on.

IMPORTANT: Perform this GFCI test once a month to ensure continued functionality of the GFCI.

11. Digital LED Indication Function (for MSD series digital inverter only)

The MSD series digital inverter combines innovative industrial design with an advanced interactive LED display.

This provides the user with instant feedback on input voltage and output loading power. These new digital inverters provide a convenient and powerful way to access AC power.

Digital inverter instantly provides information on:

- The amount of voltage remaining in the battery
- The amount of wattage an application is drawing

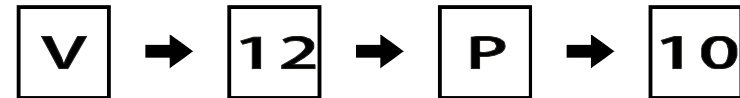

1. When display the data after the V is 12, it means that the input voltage from the battery is 12V dc.
2. When display the data after the P is 10, e.g.: if you use our 600W inverter, it means that your appliance loaded is 60W. (The P data indicates the inverter's loading rate)

12. Operating Several Loads at once

If you are going to operating several loads from the inverter, turn the loads on one at a time after you have turned the inverter on.

Turning loads on separately helps to ensure that the inverter does not have to deliver the starting current for all the loads at once, and will help prevent an overload shutdown.

Power output the inverter can deliver the power (in watts) same as the labeled in inverter continuous (e.g. The label indicate 1000Watts continuous in 1000w inverter), the wattage rating Applies to resistive loads such as incandescent lights.

Input Voltage - The allowable input voltage ranges of our inverter are shown in the following table:

OPERATING CONDITION	VOLTAGE RANGE	COMMENT
Normal	9.5-16 volts	n/a
Optimum performance	12-13 volts	n/a
Low voltage alarm	11 volts or less	the audible low battery alarm sounds
Low voltage shutdown	less than 10 volts	the inverter shutdown to protect the battery from being over-discharged
High voltage shutdown	15 volts or more	the inverter shuts down to protect itself from excessive input voltage (note: although the inverter incorporates over voltage protection, it can still be damaged if input voltage exceeds 16 volts.

13. Inverter Loads

The inverter will operate most AC loads within its power rating. However, some appliances and equipment may be difficult to operate, and other appliances may actually be damaged if you try to operate them with the inverter. Please read “high surge loads” and “trouble loads” carefully.

13.1 HIGH SURGE LOADS

Some induction motors used in freezers, pumps, and other motor-operated equipment require high surge currents to start. The inverter may not be able to start some of these motors even though their rated current draw is within the inverter’s limits. The inverter will normally start single-phase induction motors.

13.2 TROUBLE LOADS

1. Some equipment may be not work well or damaged by the inverter’s modified sine wave output.
2. Some appliances, including the types listed below, may be not work well or damaged if they

are connected to the inverter:

- Electronics that modulate RF (radio frequency) signals on the AC line will not work well or may be damaged.
- Speed controllers found in some fans, power tools, kitchen appliances, and other loads may be not working fine.
- Some chargers for small rechargeable batteries
- Metal halide arc (HMI) lights If you are unsure about powering any device with the inverter, contact the manufacturer of the device.

13.3 Connecting Appliances to the Inverter Since regular amounts of AC current flows between the inverter and your appliances, commonly available extension cords can be used to connect the inverter to your appliances. If your appliances will be connected at a considerable distance from the inverter, it is much more practical and less expensive to lengthen the AC wiring than it is to lengthen the DC wiring.

14. Routine Maintenance

14.1 Maintaining the inverter minimal maintenance is required to keep your inverter operating properly, periodically you should:

- Clean the exterior of the unit with a damp cloth to prevent the accumulation of dust and dirt.
- Ensure that DC cables are secure and fasteners are tight.
- Make sure the ventilation openings on the DC panel and bottom of the inverter are not clogged.

15. Recharging Batteries

When possible, recharge your batteries when they about 50% discharged or earlier. This gives the batteries a much longer life cycle than recharging when they are more deeply discharged.

Our inverter has a battery low voltage shutdown around 10Vdc. With moderate to heavy loads, this will protect against over-discharging the battery. If the inverter is running only light loads it is advisable to recharge before the inverter low voltage shutdown point is reached.

For more information on maintaining batteries, consult your battery’s manufacturer.

For information about our battery chargers, please contact us.

16. Battery's Capacity Calculation

The battery's back up time depends on the battery capacity(Ah)and your appliances power (Watt)

The method to calculate the operation time is :

Battery capacity(Ah) x input back up / loads power(W)

For example:

Battery capacity= 150Ah
 Input Voltage= 12V
 Loading power= 600W
 (150Ah x 12V)/600W= 3H

17. Troubleshooting

This section describes the most common problems you may encounter with the operation of the inverter along with resolutions.

If you encounter problems other than what is described in this section, contact customer supporting center.

17.1 COMMON PROBLEMS

17.1.1 Buzz in Audio Equipment

Some inexpensive stereo systems may emit a buzzing noise from their loudspeakers when operated from the inverter. This occurs because the power supply in the audio System does not adequately filter the modified sine wave produced by the inverter.

The only solution is to use a sound system that has a high quality power supply.

17.1.2 Television Reception

When the inverter is operating, it can interfere with televisionReception on some channels. If interference occurs, try the following:

1. Make sure that the chassis ground screw on the rear of the inverter is solidly connected to the ground system of your vehicle or home.
2. Make sure that the television antenna provides an adequate (" snow-free ") signal and that you are using good quality cable between the antenna and the television.
3. Keep the cables between the battery and the inverter as short as possible, and twist them together with two to three twists per foot.(this minimizes radiated interference from the cables.)
4. Move the television as far away from the inverter as possible.

5.Do not operate high power loads with the inverter when the television is on.

! DANGER

ELECTRICAL SHOCK HAZARD

Do not disassemble the inverter. It does not contain any user-serviceable parts.
 Failure to follow these instructions can result in death or serious injury.

17.2 TABLE 1 TROUBLESHOOTING REFERENCE

Problem	Possible Cause	Solution
Low output voltage	You are using a voltmeter that cannot accurately read the RMS voltage of a modified sine wave. Low input voltage and the load is close to maximum allowable power	Use a true RMS reading voltmeter such as the Fluke87. Check the connections and cable to see if the battery is fully charged. Recharge the battery if it is low. Reduce the load.
No output voltage. Both the power light and fault light are off	The inverter is off. No power to the inverter. The inverter could have been connected with reverse DC input polarity	Turn the inverter on. Check the wiring to the inverter and to the battery selector switch (if installed). The inverter has probably been damaged. Return the unit, damage caused by reverse polarity is not covered by the warranty
No output voltage. Fault light is on	Low input voltage High input voltage Thermal shutdown Unit overload Output is short circuited	Recharge the battery, check the connections and cable. Make sure the inverter is connected to a correct battery (12V inverter for 12V battery or batteries bank) Allow the unit to cool off. Reduce the load if continuous operation is required. Improve ventilation. Make sure the inverter's ventilation openings are not obstructed. Reduce the ambient temperature. Reduce the load. Make sure the load does not exceed the inverter's output rating. Remove the short circuit
Low battery alarm stays on	Poor DC wiring, poor battery condition	Use proper cable size and lengths and make solid connections Charge the battery Install a new battery

18.1 Electrical specifications for MS series inverter

Model	MS3300	MS400	MS500	MS600	MS700	MS800	MS1000	MS1200	MS1500	MS2000	MS2500	MS3000	MS3500
Maximum continuous output Power	300W	400W	500W	600W	700W	800W	1000W	1200W	1500W	2000W	2500W	3000W	3500W
Maximum Surge Power	600W	800W	1000W	1200W	1400W	1600W	2000W	2400W	3000W	4000W	5000W	6000W	7000W
Operating temperature range	0~40°C (32~104°F)												
Output voltage Range	100~120V / 220~240V												
Output waveform	Modified Sine Wave \sim U \sim L \sim r												
Output frequency	50/60Hz \pm 3												
USB port	5V 500mA or 800mA (optional)												
Input voltage range	19~30V												
Low battery alarm	21 \pm 1V												
Low battery shutdown	19 \pm 1V												
Over voltage shutdown	15 \pm 0.5V												
Short circuit protection	Shutdown and cutout the output												
Over temperature protection	Shutdown and cutout the output												
Polarity reverse protection	By internal fuse open												
Optimum efficiency	\geq 90%												
No load current draw	\leq 0.25A	\leq 0.3A	\leq 0.35A	\leq 0.4A	\leq 0.45A	\leq 0.5A	\leq 0.6A	\leq 0.7A	\leq 0.85A	\leq 1.1A	\leq 1.35A	\leq 1.6A	\leq 1.85A
Replaceable fuse	12V 40A*1	50A*1	30A*1	40A*1	50A*1	50A*1	12V 30A*4	40A*4	40A*5	20V 110V	20V 110V	20V 110V	20V 110V
							24V 15A*4	20A*4	20A*5	20V 110V	20V 110V	20V 110V	20V 110V
	24V 20A*1	25A*1	15A*1	20A*1	25A*1	25A*1	48V 7.5A*4	10A*4	10A*5	20V 110V	20V 110V	20V 110V	20V 110V
										20V 110V	20V 110V	20V 110V	20V 110V
Remote Control	NO												
	Optional, if choose the inverter with remote control Then there is remote switch with 5m communication Wire inside packing												

18.2 Physical specifications for MS series inverter

Unit Dimensions(cm)	18*13.4*5.8	18*13.4*5.8	22*13.4*5.8	22*13.4*5.8	23*13.4*5.8	23*13.4*5.8	26*13.4*5.8	26*13.4*5.8	26*13.4*5.8	32*13.4*5.8	32*13.4*5.8	32*13.4*5.8	41*23*10.8
Unit weight(g)	700	740	950	1000	1100	1250	3050	3100	3850	5850	5900	7500	7550

Note: Specifications are subject to change without prior notice.

18.3 Electrical specifications for MSD series digital inverter

Model	MSD300	MSD400	MSD500	MSD600	MSD700	MSD800	MSD1000	MSD1200	MSD1500	MSD2000	MSD2500	MSD3000	MSD3500
Maximum continuous output Power	300W	400W	500W	600W	700W	800W	1000W	1200W	1500W	2000W	2500W	3000W	3500W
Maximum Surge Power	600W	800W	1000W	1200W	1400W	1600W	2000W	2400W	3000W	4000W	5000W	6000W	7000W
Operating temperature range	0~40°C (32~104°F)												
Output voltage Range	100~120V / 220~240V												
Output waveform	Modified Sine Wave \sim U \sim L \sim r												
Output frequency	50/60Hz \pm 3												
Output digital display	V.P constantly (Volt, Power)												
USB port	5V 500mA or 800mA (optional)												
Input voltage range	19~30V												
Low battery alarm	21 \pm 1V												
Low battery shutdown	19 \pm 1V												
Over voltage shutdown	15 \pm 0.5V												
Short circuit protection	Shutdown and cutout the output												
Over temperature protection	Shutdown and cutout the output												
Polarity reverse protection	By internal fuse open												
Optimum efficiency	\geq 90%												
No load current draw	\leq 0.25A	\leq 0.3A	\leq 0.35A	\leq 0.4A	\leq 0.45A	\leq 0.5A	\leq 0.6A	\leq 0.7A	\leq 0.85A	\leq 1.1A	\leq 1.35A	\leq 1.6A	\leq 1.85A
Replaceable fuse	12V 40A*1	50A*1	30A*1	40A*1	50A*1	50A*1	12V 30A*4	40A*4	40A*5	20V 110V	20V 110V	20V 110V	20V 110V
							24V 15A*4	20A*4	20A*5	20V 110V	20V 110V	20V 110V	20V 110V
	24V 20A*1	25A*1	15A*1	20A*1	25A*1	25A*1	48V 7.5A*4	10A*4	10A*5	20V 110V	20V 110V	20V 110V	20V 110V
										20V 110V	20V 110V	20V 110V	20V 110V
Remote Control	NO												
	Optional, if choose the inverter with remote control Then there is remote switch with 5m communication Wire inside packing												

18.4 Physical specifications for MSD series digital inverter

Unit Dimensions(cm)	17.5*10.25*5.58	17.5*10.25*5.58	22.5*10.25*5.58	22.5*10.25*5.58	23.5*10.25*5.58	26.5*10.25*5.58	26.5*10.25*5.58	26.5*10.25*5.58	33.5*23*10.8	33.5*23*10.8	33.5*23*10.8	41*23*10.8	41*23*10.8
Unit weight(g)	660	670	880	900	2100	2250	3150	3200	4000	6000	6100	8500	9000

Note: Specifications are subject to change without prior notice.

19. Disposal instructions

HOME ELECTRONIC EQUIPMENT: If you no longer wish to use this appliance, please take it to the applicable collection point or deliver it to a public recycling location for old electronic equipment. Electronic equipment shall under no circumstances be disposed of in the same manner as normal household waste (see the crossed-out garbage can symbol below).

FURTHER DISPOSAL INSTRUCTIONS: Hand over the appliance in a condition that will allow for safe recycling and disposal. Remove all batteries from the appliance in advance and prevent any liquid containers from being damaged. Electronic equipment may contain harmful substances. Improper use or malfunction caused by damage may adversely affect human health and harm the environment during recycling.



WARRANTY CARD

20. Warranty and service agreements

This warranty covers only manufacturing defects. The appliance must not be modified or altered in any way with regards to both form and function. This warranty does not apply in case of improper usage; usage that falls beyond normal use as indicated in the user's manual or if there is damage caused by force majeure (e.g. natural disaster). Only clean and intact appliances will be accepted for warranty and non-warranty repair. The standard warranty period is 24 months starting from the purchase date. In order to make a warranty claim, this warranty card must be submitted along with proof of purchase, including the model number, purchase date and a dealer's stamp.

Model number:.....

Purchase date:

Dealer's stamp and signature:

Date of warranty claim:

Defect(s) noted: